

4 - 8 YEARS

PREVENTION OF

DOMESTIC ACCIDENTS

Color the **dangerous elements** in each scene.

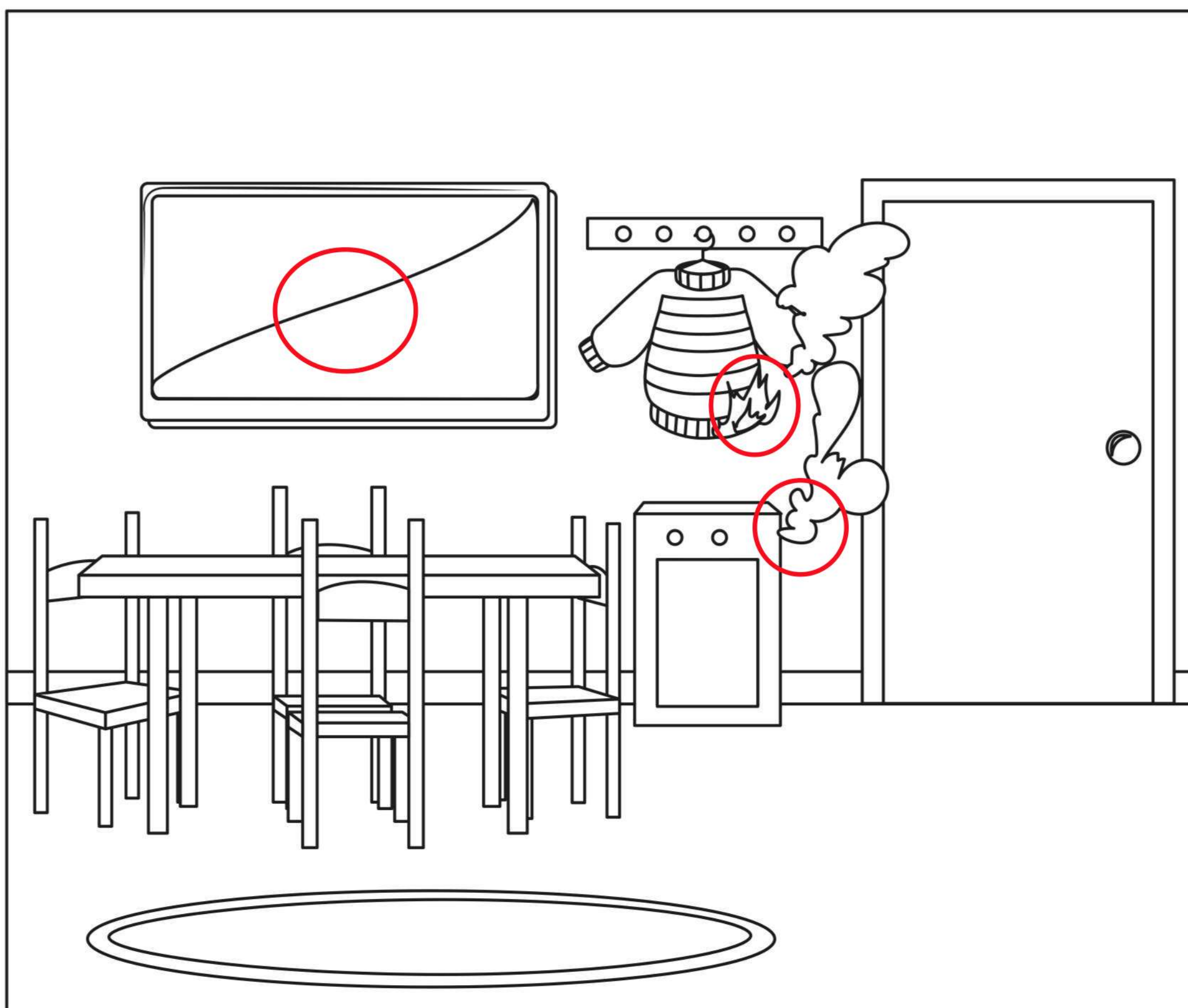
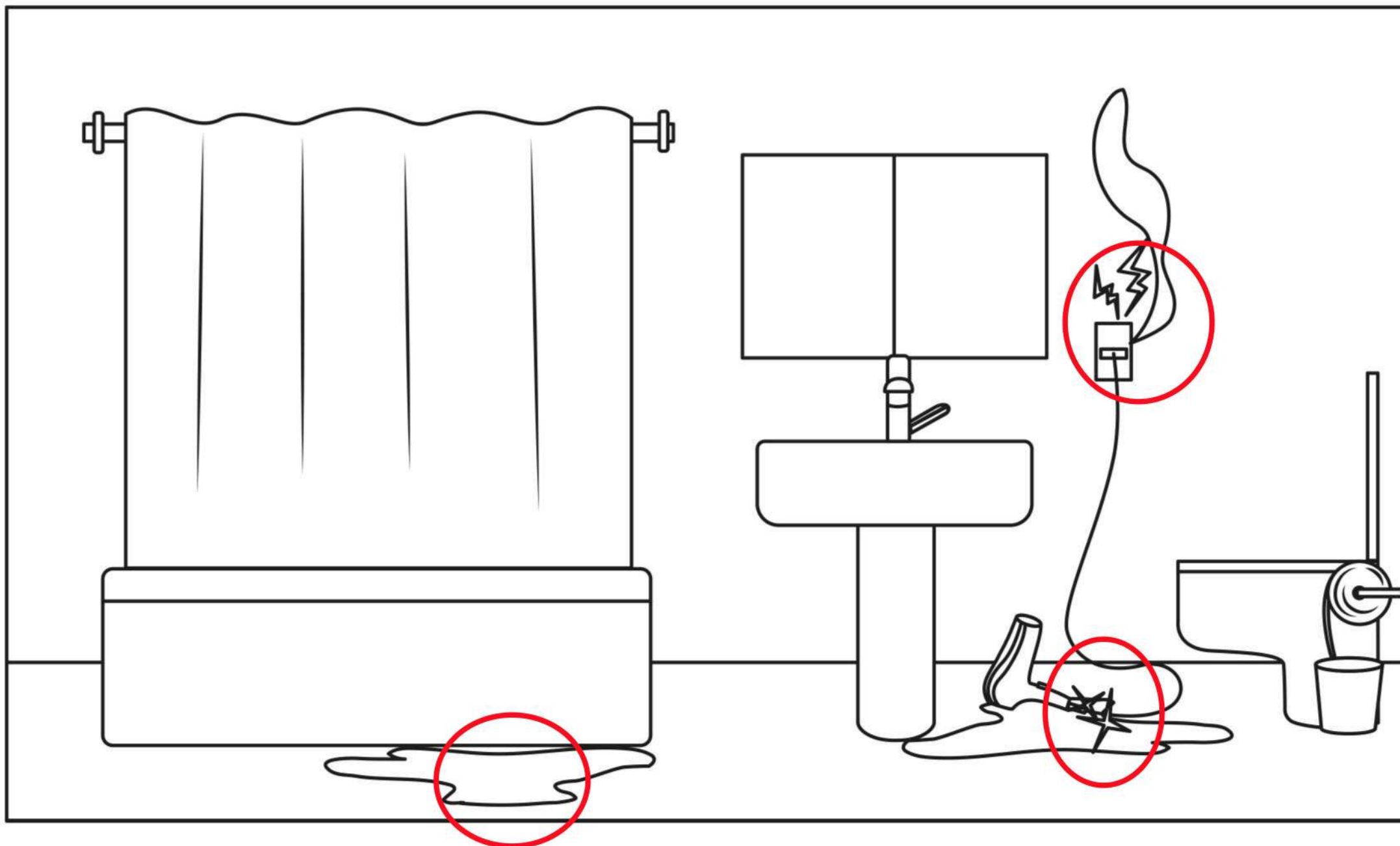

4-8 YEARS



First Aid
Reference
Centre

PREVENTION OF

DOMESTIC ACCIDENTS

Color the **dangerous elements** in each scene.

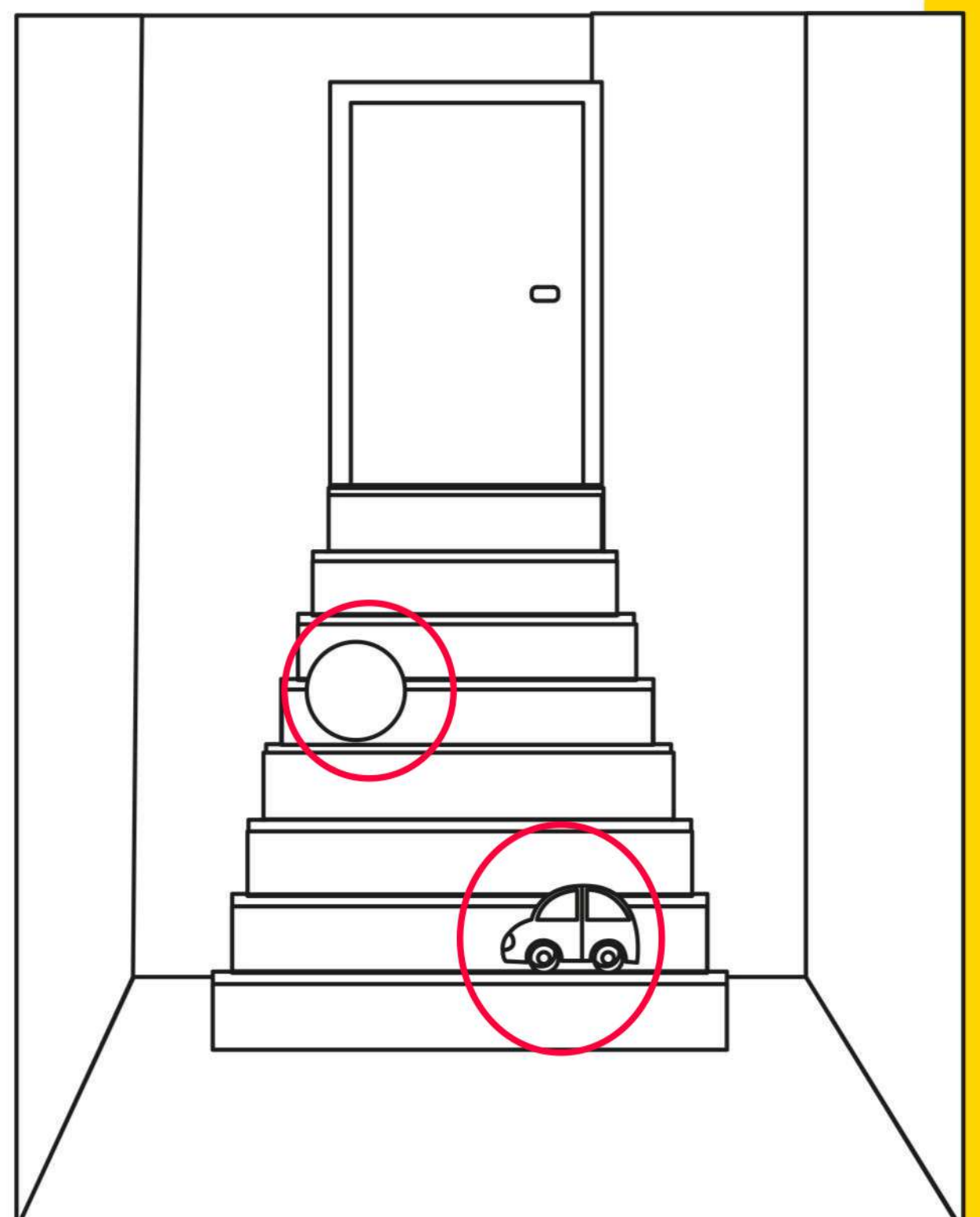
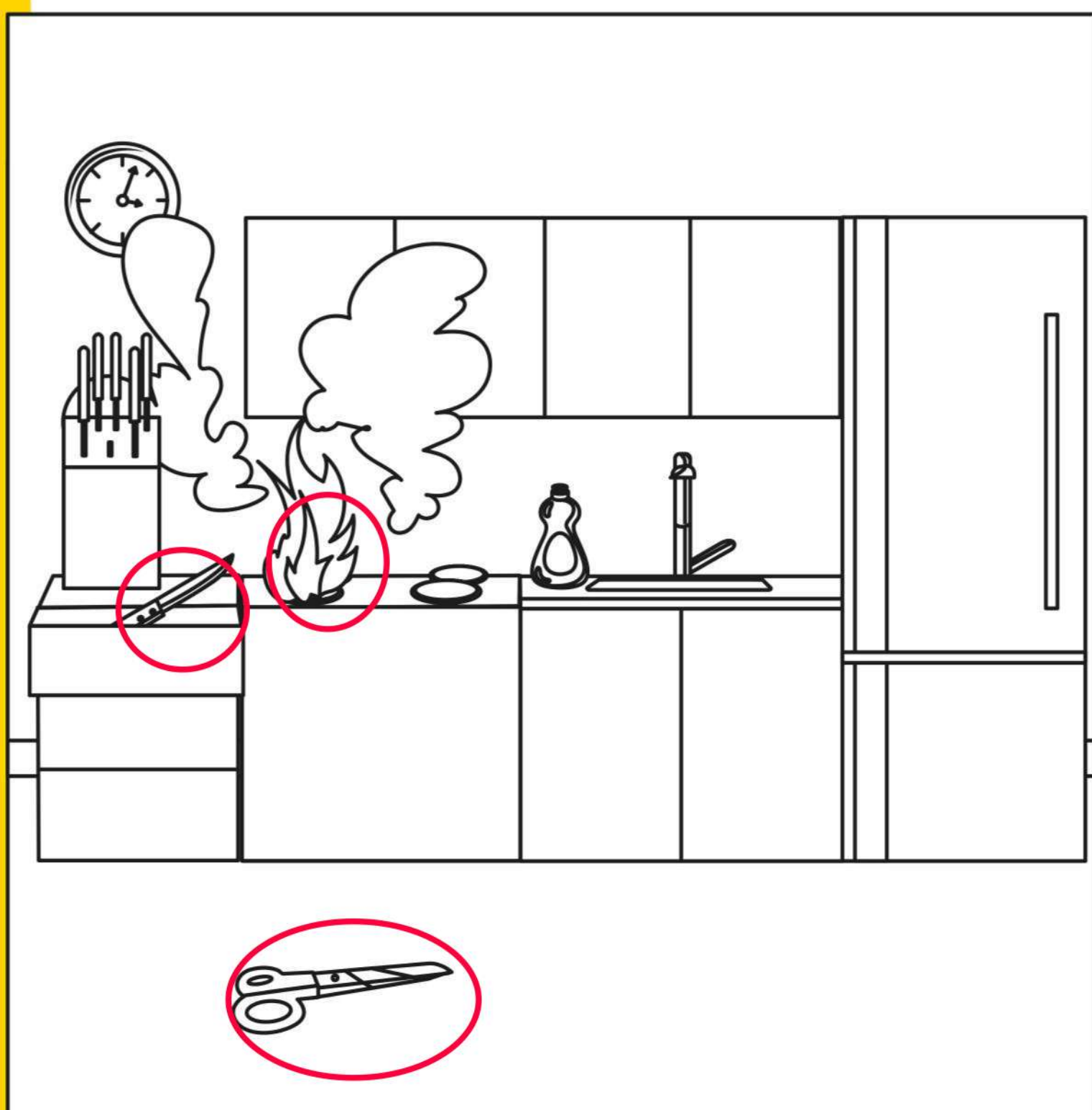
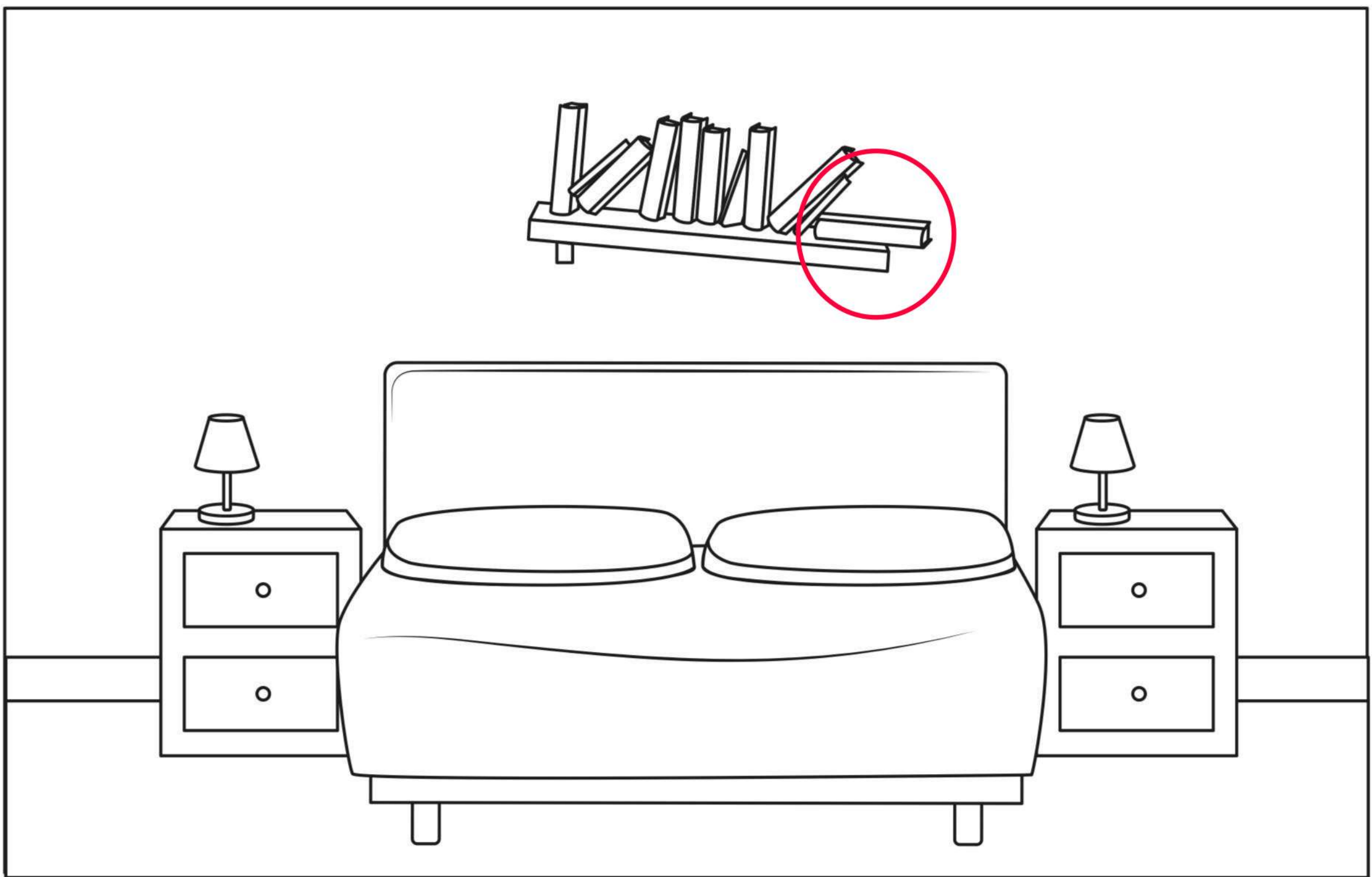

4 - 8 YEARS

FIRST-AID KIT

Color the objects
that fit in the first aid
kit.

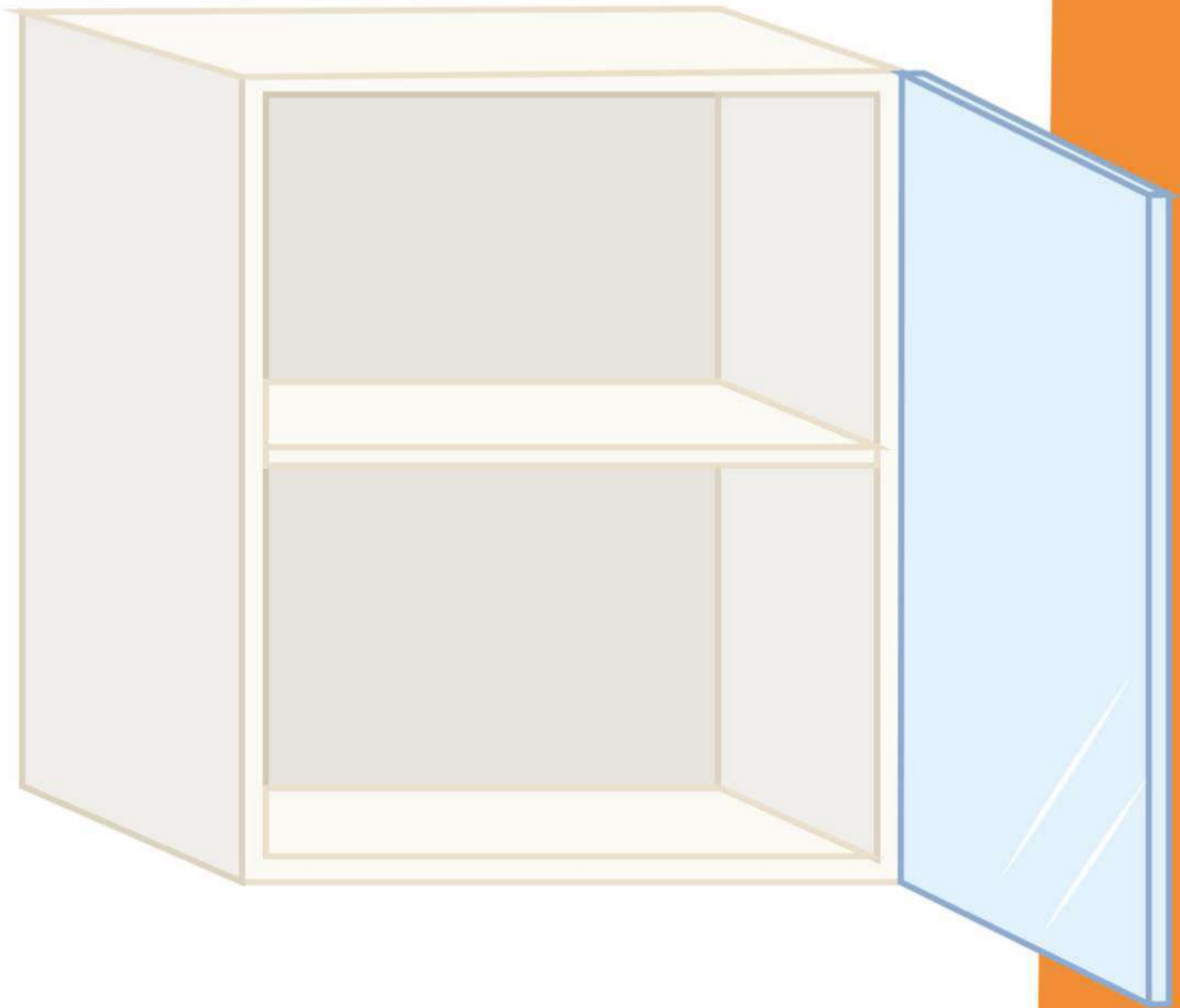

4 - 8 YEARS

RECOGNIZE & RESPOND

TO AN EMERGENCY

Write in the grey box the telephone number that
corresponds to **each vehicle.** Then, color.

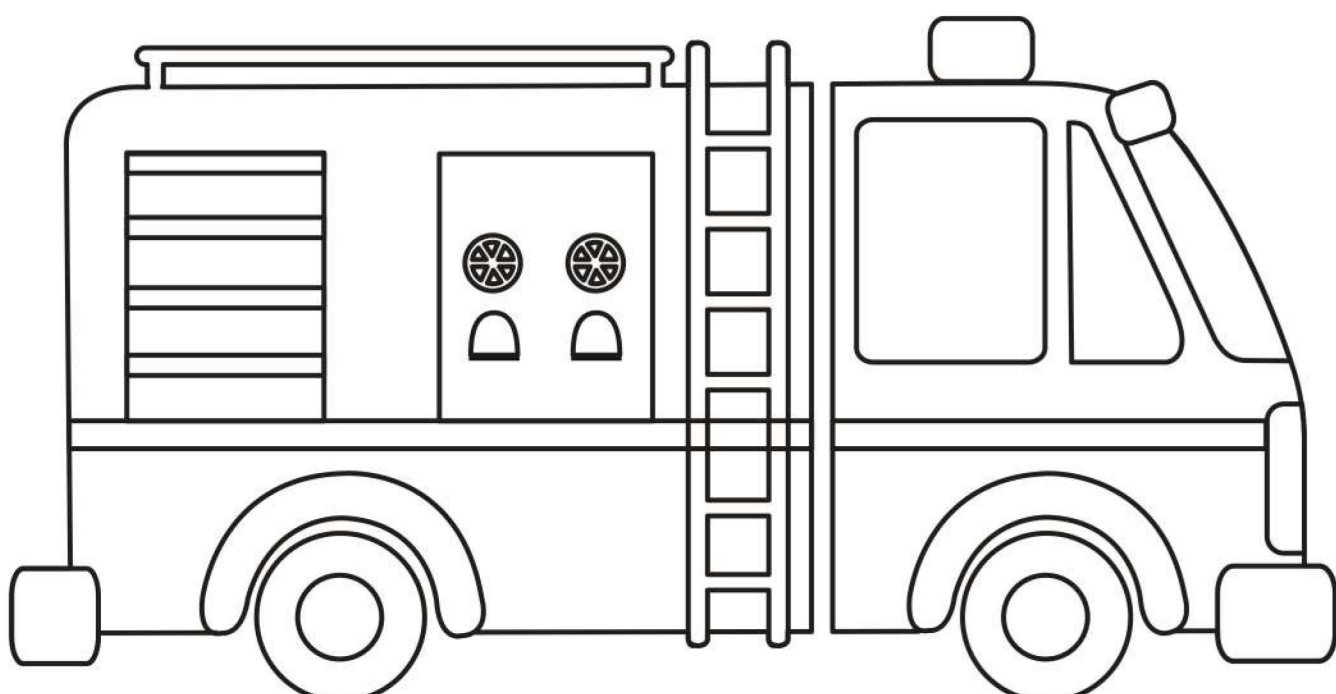
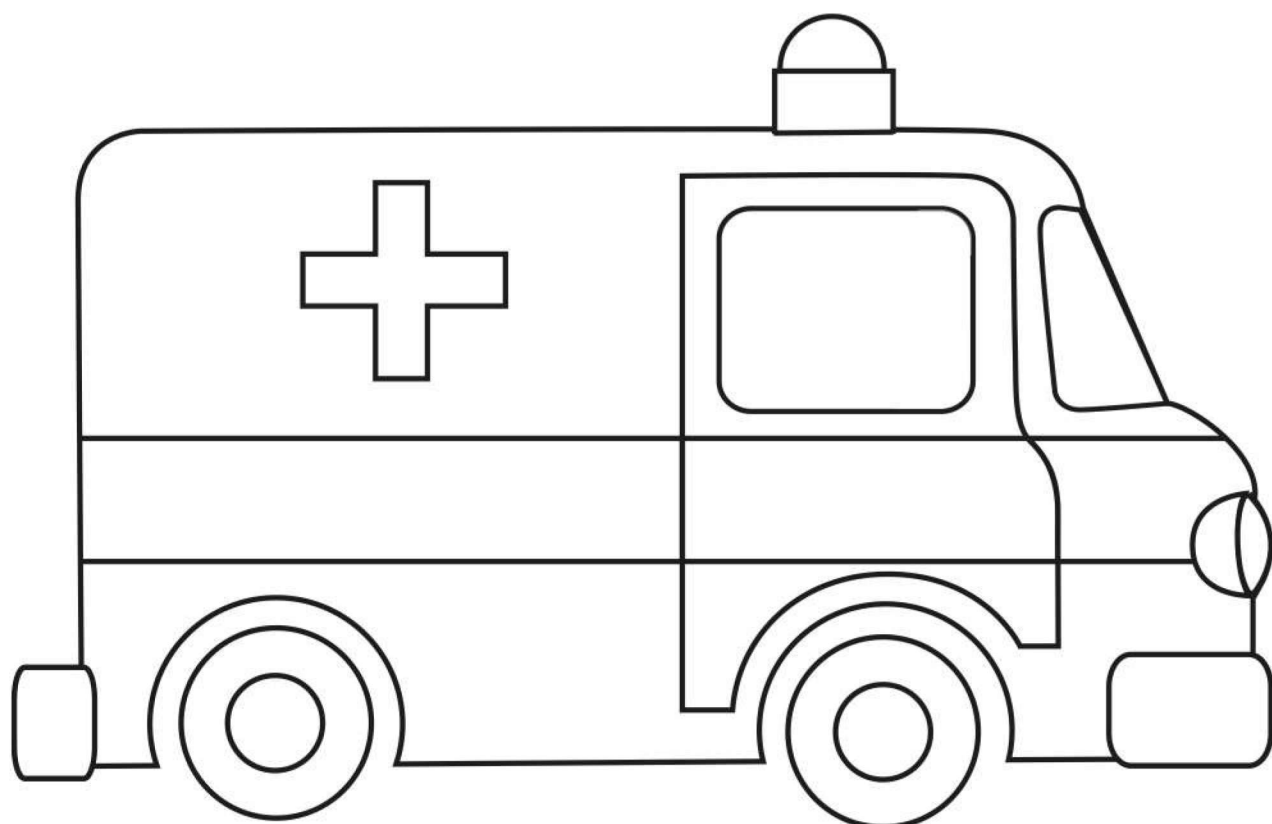
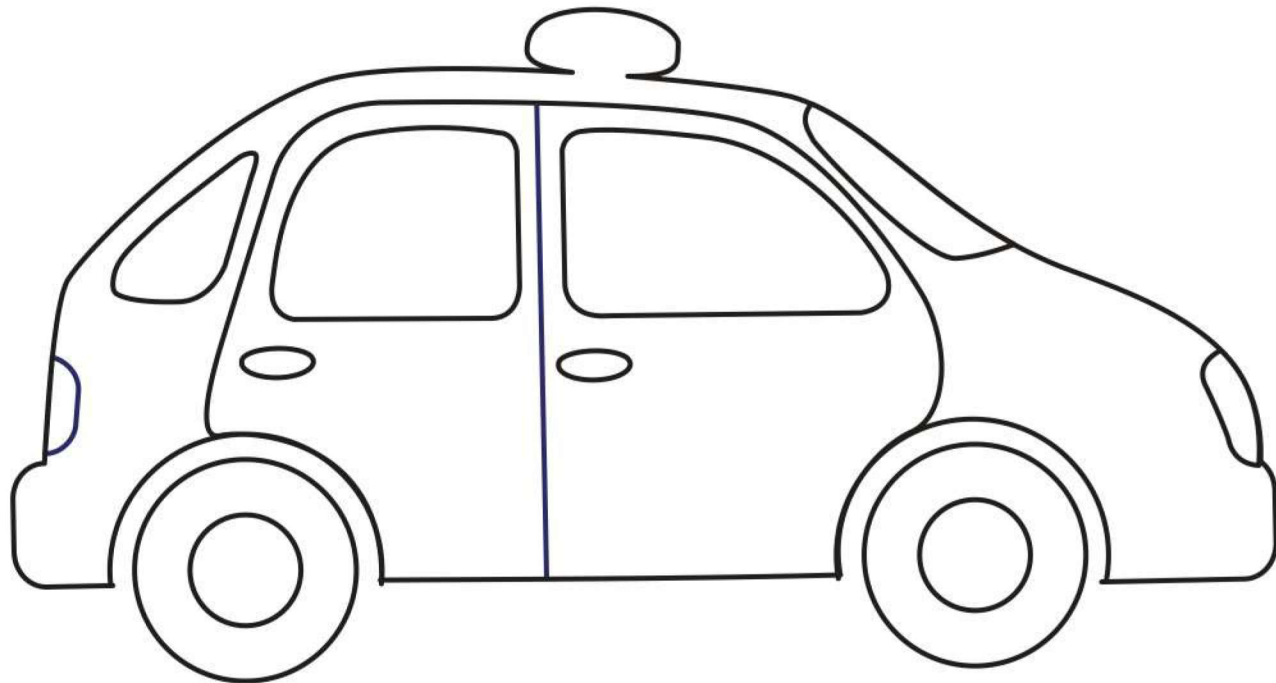

4 - 8 YEARS



First Aid
Reference
Centre

WOUNDS & BLEEDING

CUTS AND GRAZES

DAILY BURNS

Using arrows connect each situation. Then color.

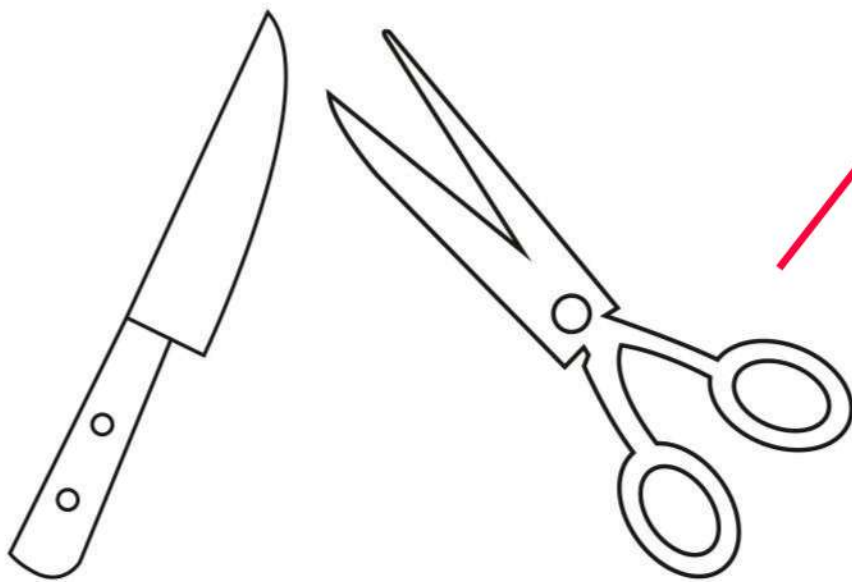
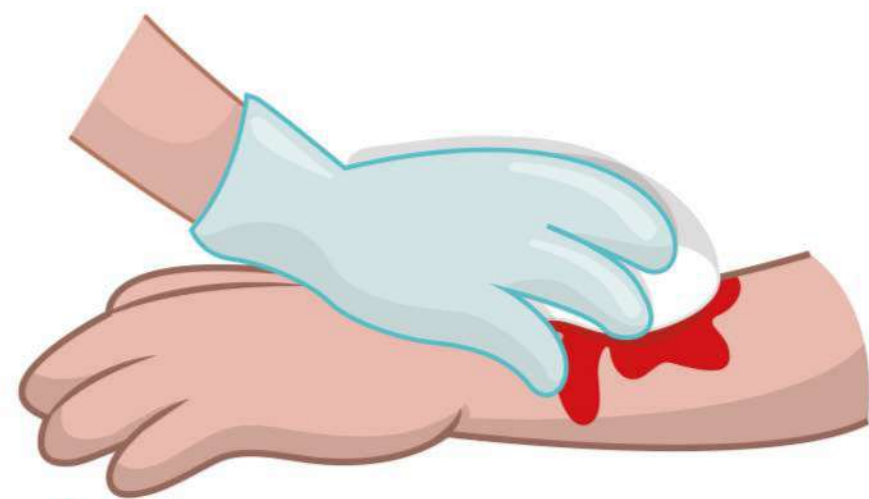

4 - 8 YEARS



First Aid
Reference
Centre

CARDIOPULMONARY RESCUSCITATION (CPR)

STROKE

CHOKING : OBSTRUCTED AIRWAY MANEUVER

Color the same as **the image in color.**

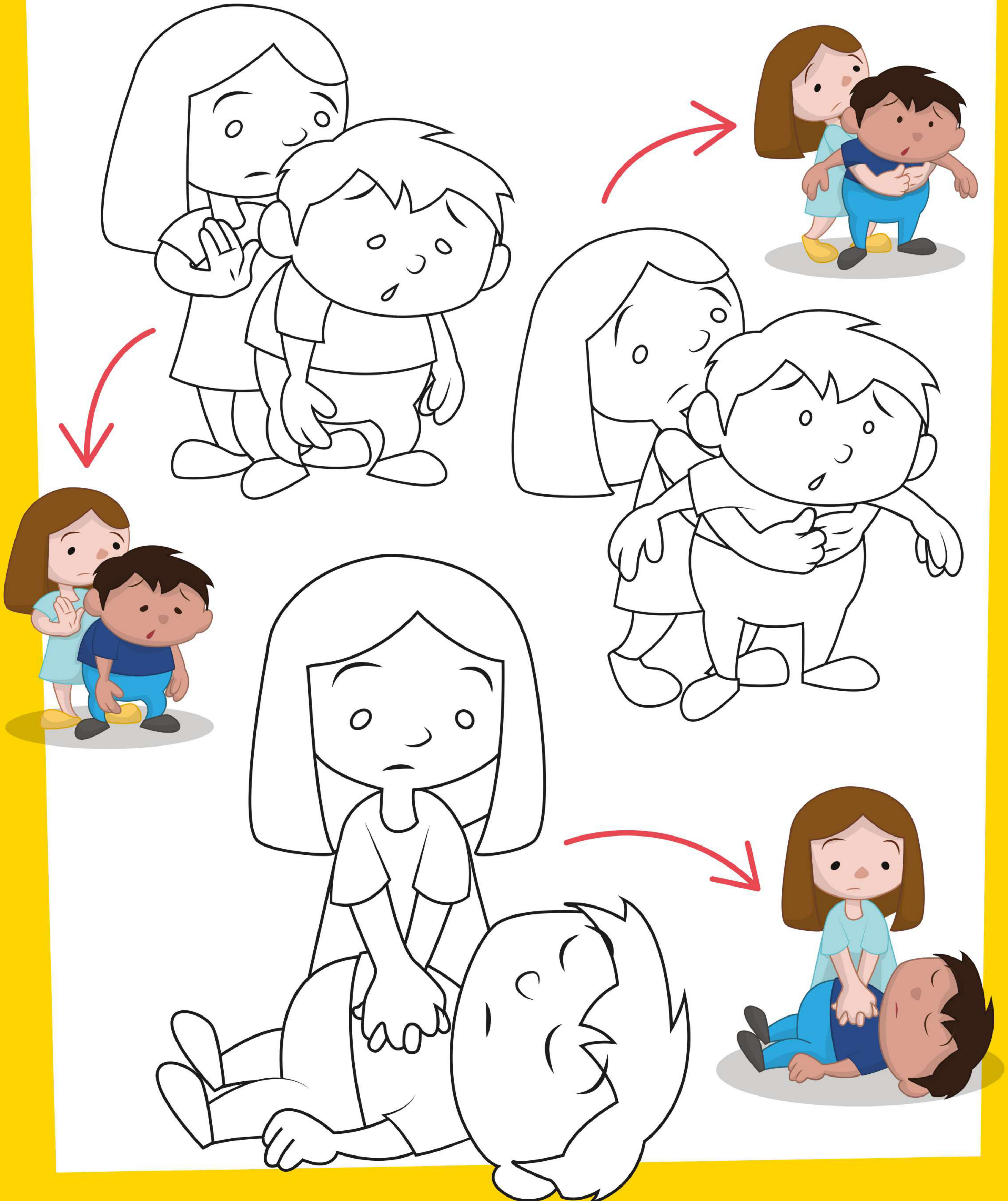

4 - 8 YEARS



First Aid
Reference
Centre

INTOXICATION

Cross out **toxic** products.

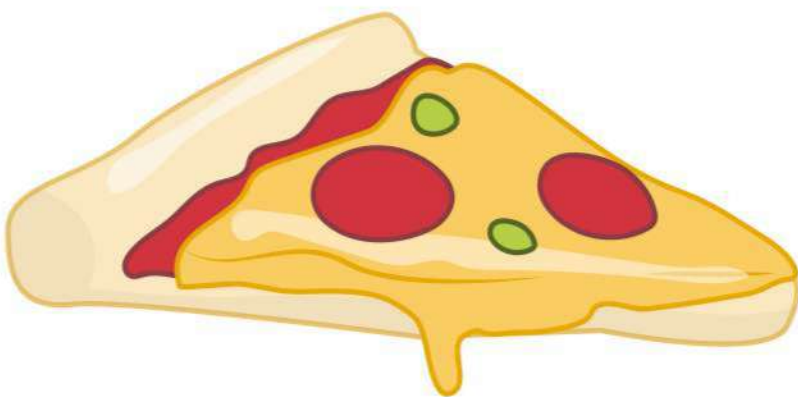
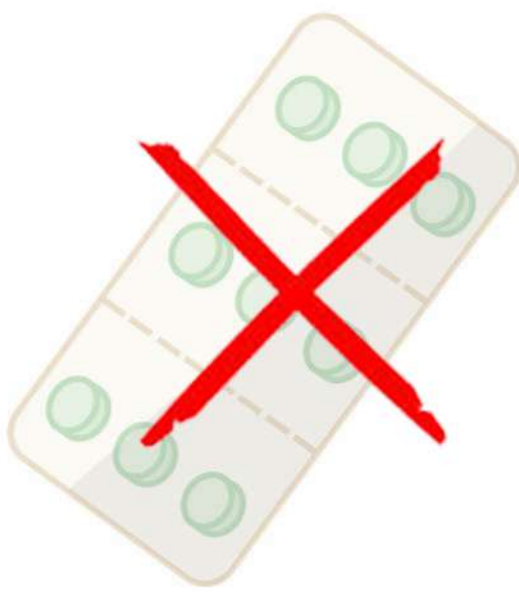
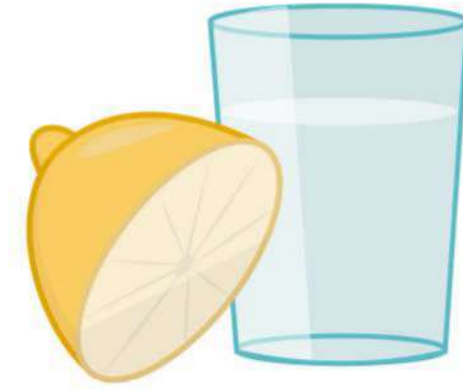

4 - 8 YEARS

RISKS RELATED TO COLD OR HEAT

How to protect yourself from cold or heat? Connect the images using arrows.

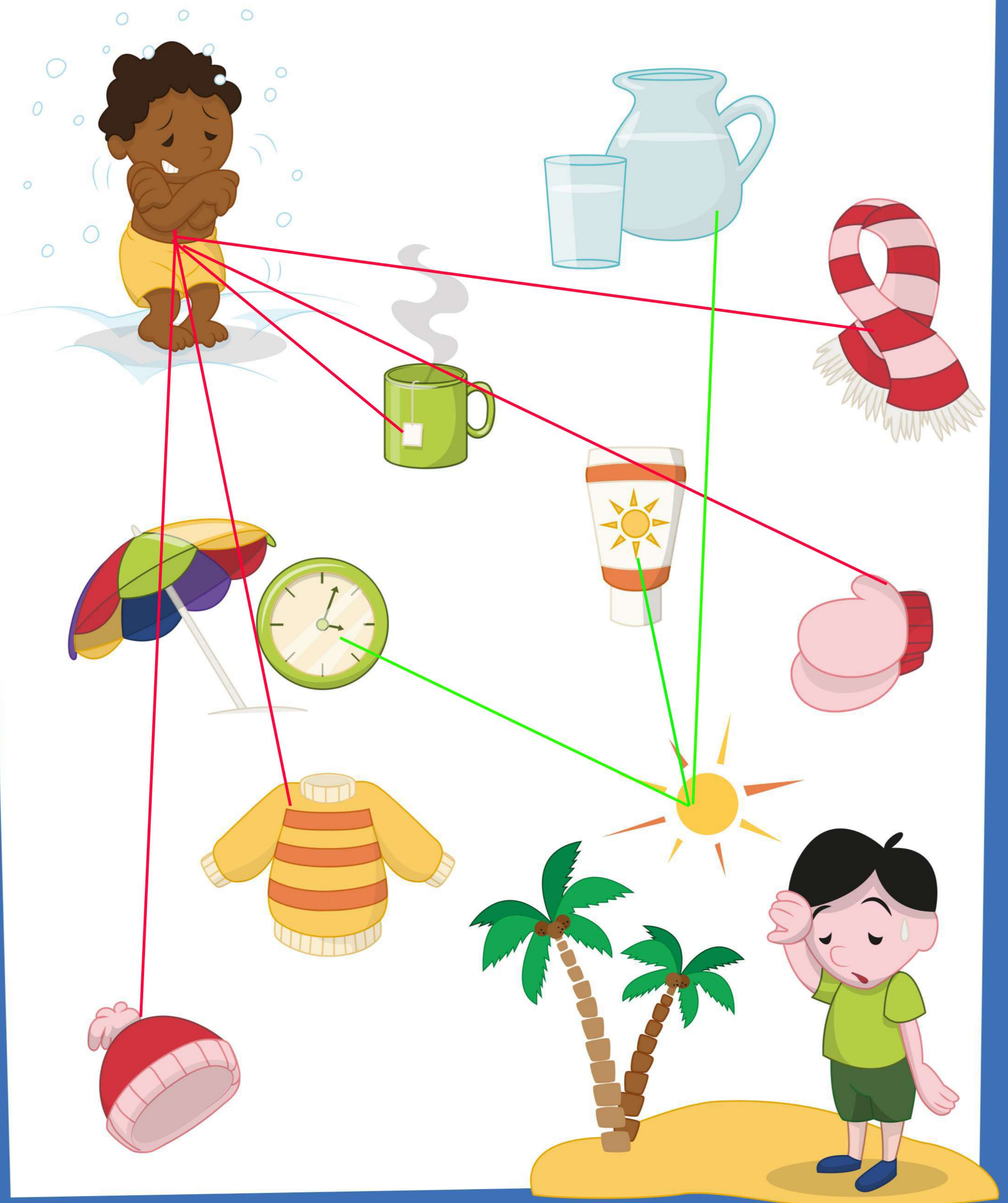

4 - 8 YEARS

INSECT STINGS

ANIMAL BITES

Connect with arrows the type of bite/sting that corresponds to each animal/insect.

